

VOLMED

Serving Healthcare Since 1971



GENERAL SURGICAL INSTRUMENTS CATALOG

www.volmed.co.uk

About Us

With over 50 years of industry experience, VOLMED is a family-owned company specializing in the supply of high-quality surgical instruments to the medical and surgical markets across the United Kingdom, Europe, and globally. Our extensive expertise enables us to assist with project research and development, ensuring that we meet the evolving needs of our clients.

Our philosophy is simple: we treat our customers as we would like to be treated, which places customer satisfaction at the forefront of our priorities. This approach naturally aligns with our commitment to delivering products of the highest quality. Ultimately, our goal is to empower you to provide the best possible care and achieve improved health outcomes by streamlining the process of stocking your practice.

We take pride in the breadth of our product offerings, understanding that sourcing medical tools and surgical instruments from multiple suppliers can be both time-consuming and challenging. To address this, we strive to be your one-stop shop for all your requirements.

Our History

Our story began over 50 years ago within a family deeply rooted in the medical instrument manufacturing industry. The foundation of our thriving business was built by a team of highly ambitious professionals with expertise in producing plastic surgery, dental and surgical instruments.

Inspired by the potential for excellence, our founder established VOLMED, a company dedicated to providing outstanding customer service and high-quality products. Since then, our team of dedicated professionals has worked tirelessly to ensure that customers worldwide receive only the finest surgical instruments and related services. We never compromise on quality, continually investing in our team, resources, equipment, and processes. Every detail is meticulously examined to ensure we can adapt to changing demands while maintaining the highest standards of quality.

Our Promise

At VOLMED, our commitment to excellence is unwavering. We strive to achieve the highest standards in everything we do, working relentlessly to provide exceptional service to our customers and everyone associated with our company. We view it as our responsibility to contribute to a better future for the entire community, and we are dedicated to making this vision a reality.

Quality

Our commitment to quality is reflected in our CE and UKCA-marked instruments, manufactured in accordance with stringent global quality assurance standards, including ISO 9001:2015, ISO 13485:2016, and the Medical Device Directive 93/42/EEC.

Our Mission

We are committed to manufacturing and supplying products that meet the highest standards of strength, accuracy, and reliability. Recognizing the critical role our equipment plays in saving lives and improving health, we take this responsibility seriously. Our mission is to simplify the procurement process by offering a comprehensive range of high-quality surgical products under one roof.

Products

At VOLMED, surgical instruments are at the core of our offerings. We provide a wide range of high-quality surgical products suitable for use in operating rooms, wards, veterinary practices, dentistry, and chiropody. Our instruments are crafted to strict standards using a blend of modern technology and traditional craftsmanship, in full compliance with the Medical Devices Directive 93/42/EEC. Complete traceability is maintained throughout the manufacturing process.

To ensure exceptional product performance and reliability, all our products undergo rigorous engineering analysis and stringent inspection methods. VOLMED instruments are guaranteed for five years against manufacturing defects and are made from premium surgical-grade stainless steel, in accordance with ISO 7153-1:2016 specifications. Explore our product listings and catalogues to discover our comprehensive range of surgical instruments.



Serving Healthcare Since 1971

Sterilization

Serving Healthcare Since 1971



39

39

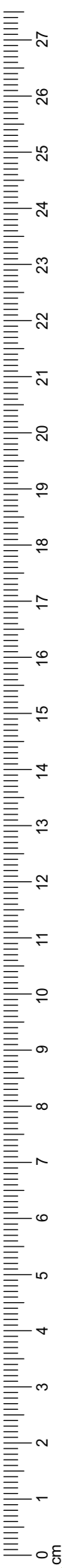

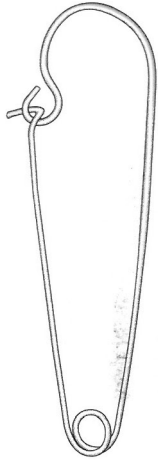

Bunt
V-039-200
 12 cm / 4¾"

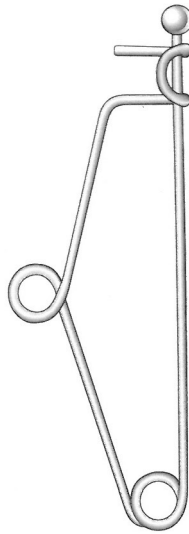

Mayo
V-039-202
 14 cm / 5½"

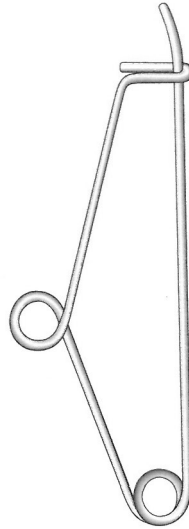

Mayo
V-039-204
 14 cm / 5½"

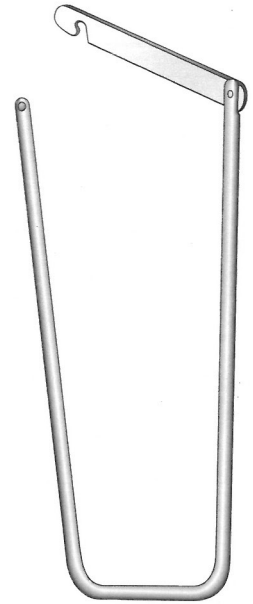

Surgicon
V-039-210 20 cm / 8"
V-039-212 25 cm / 10"
V-039-214 30 cm / 12"
V-039-216 40 cm / 16"
 With secure locking device

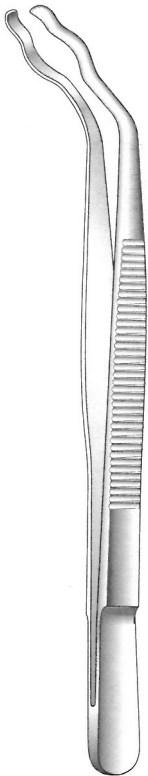

Davis
V-039-221 16 cm / 6¼"
V-039-222 20 cm / 8"
V-039-223 24 cm / 9½"

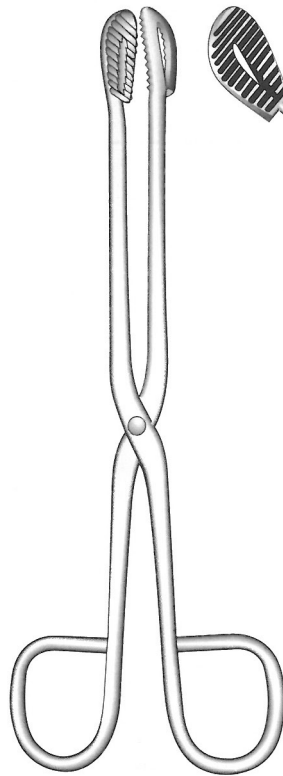

Universal
V-039-224 20 cm / 8"
V-039-225 28 cm / 11"
 Straight



V-039-226 20 cm / 8"
V-039-227 28 cm / 11"
 Angled

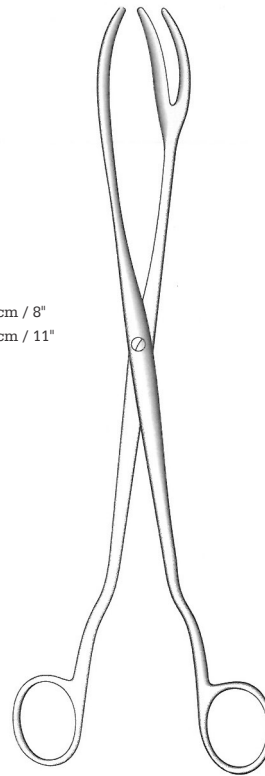

V-039-228 20 cm / 8"
V-039-229 30 cm / 12"

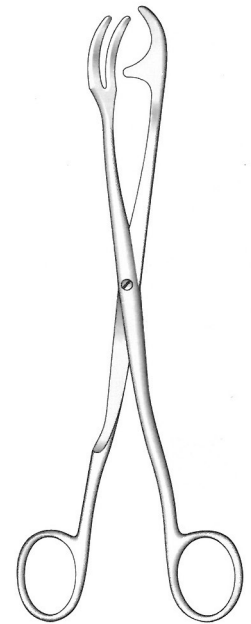

Rogge
V-039-230
 23 cm / 9"

Sterilization

Sterilizing Waste Forceps

Forcepskappenzangen

Combinacion tapa/pinza

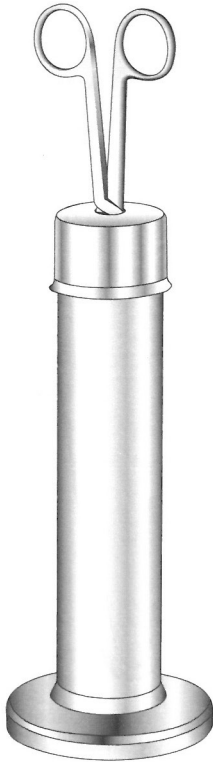

V-039-236 25 cm / 10 "
V-039-260 32 cm / 12 3/4 "
with ratchet

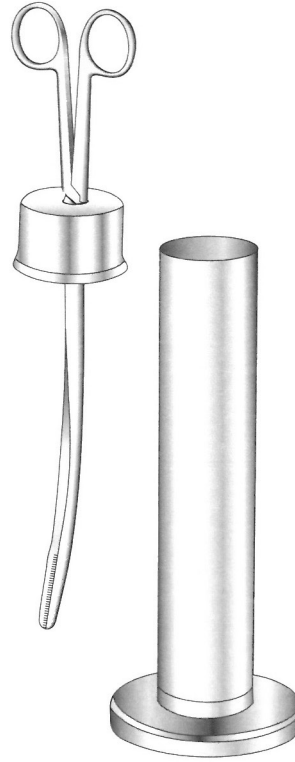

V-039-237 25 cm / 10 "
V-039-261 32 cm / 12 3/4 "
without ratchet

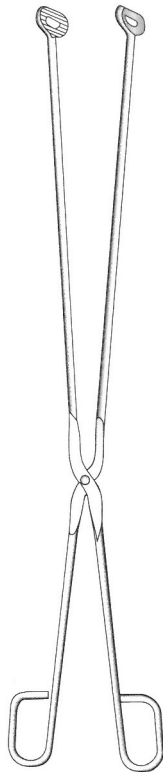

Modell
V-039-238
58 cm / 22 3/4 "

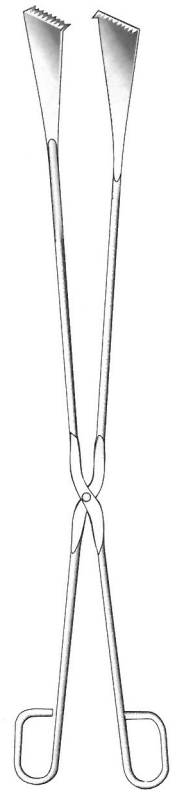

Sauerbruch
V-039-239
55 cm / 21 1/2 "

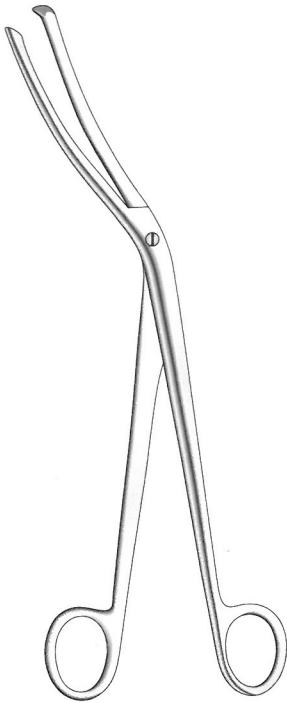

Cheatele
V-039-240
 26.5 cm / 10½"

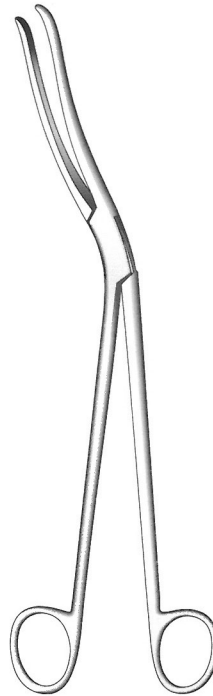

Cheatele
V-039-241
 27 cm / 10½"

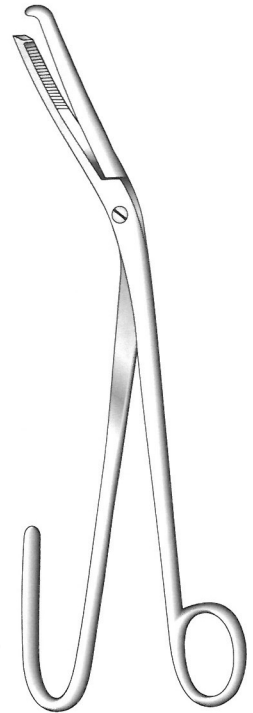

Cheatele
V-039-242
 28 cm / 11"

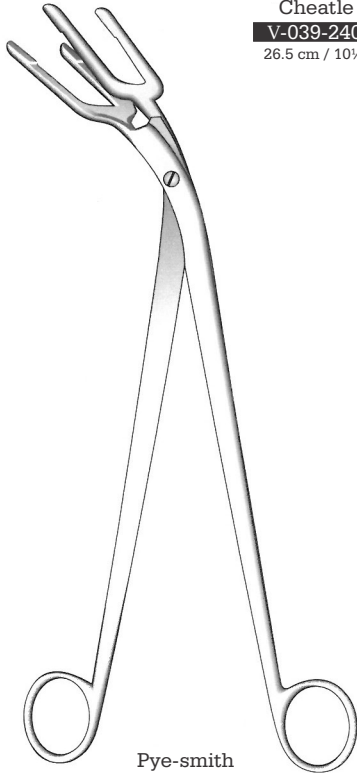

Pye-smith
 Harrison
V-039-243 25 cm / 10"
V-039-244 30 cm / 12"

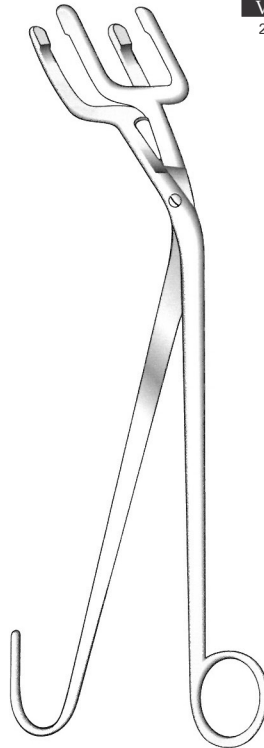

Harrison
V-039-245 25 cm / 10"
V-039-246 30 cm / 12"
V-039-247 35 cm / 14"
V-039-248 45 cm / 18"

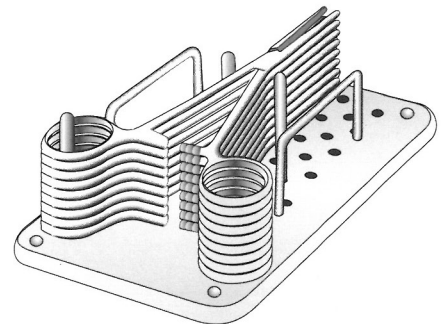

V-039-249



Serving Healthcare Since 1971

CONTACT US

Creative Industries Centre,
Glaisher Drive Wolverhampton Science Park,
Wolverhampton United Kingdom,
WV10 9TG

Email queries:

info@volmed.co.uk / sales@volmed.co.uk

www.volmed.co.uk